

Berufsschule
21.10.53-Z1

Projektion v. Prismen

PFT 1A 1

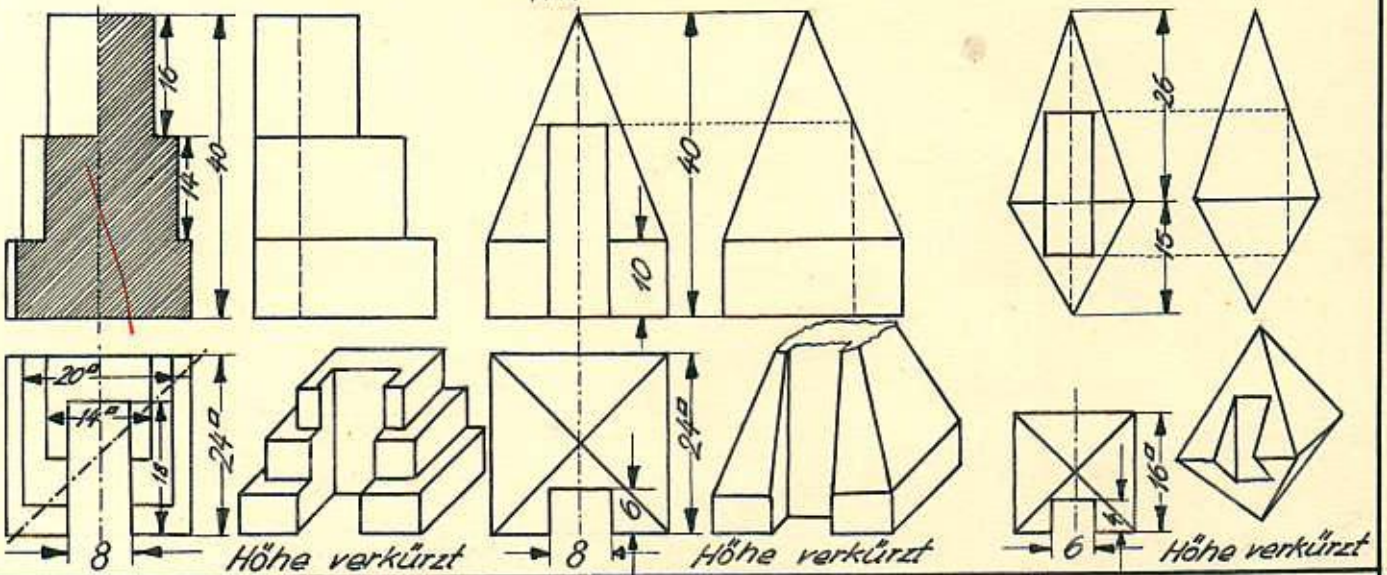
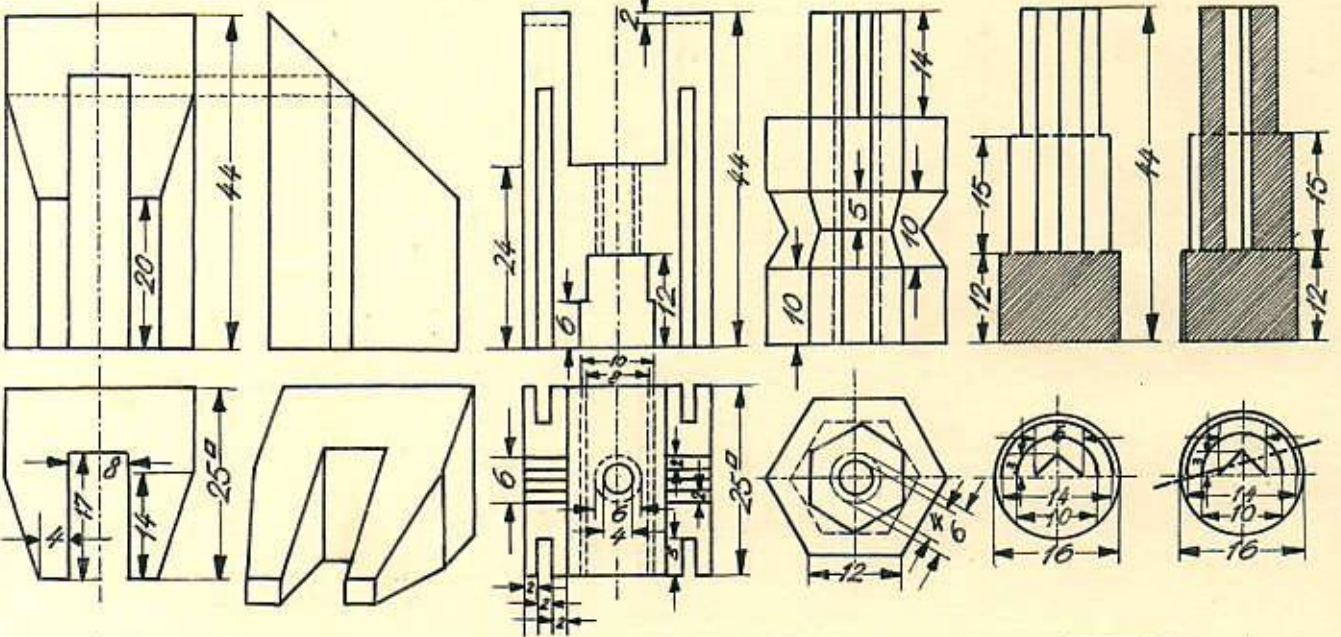
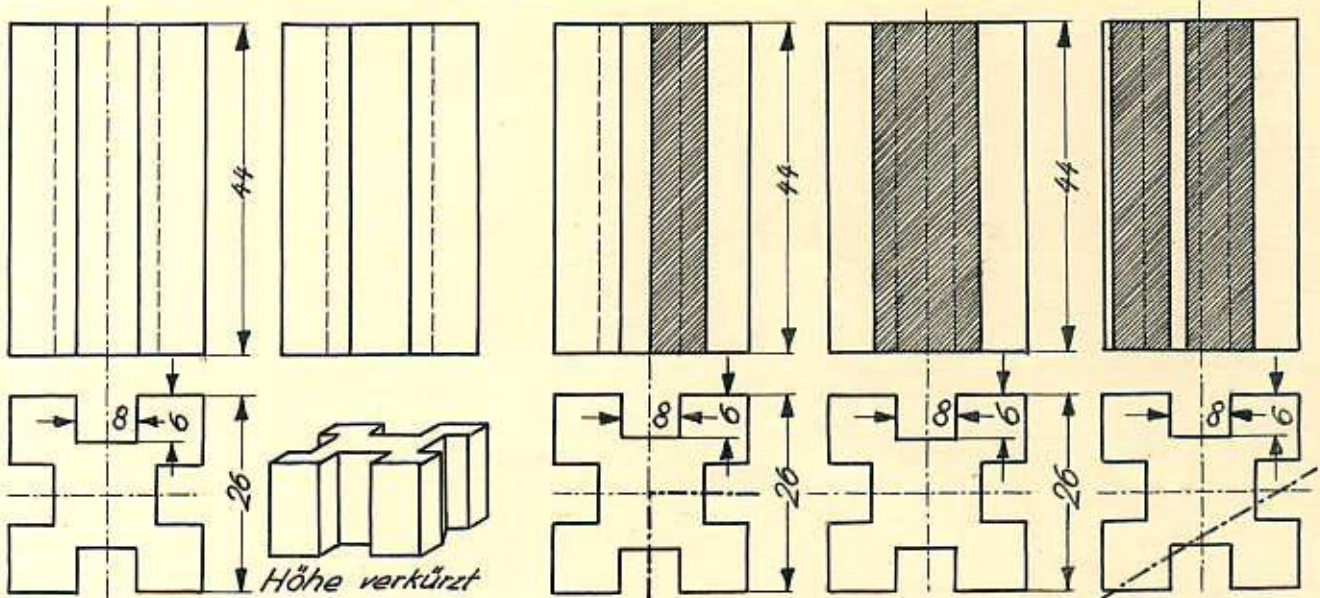

Berufsschule

10.2.54-Z2

Projektionen

PFT 1A $\frac{1}{2}$

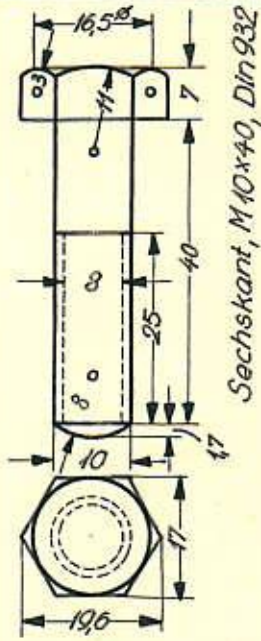

Sechskant, M 10 x 40, Din 932

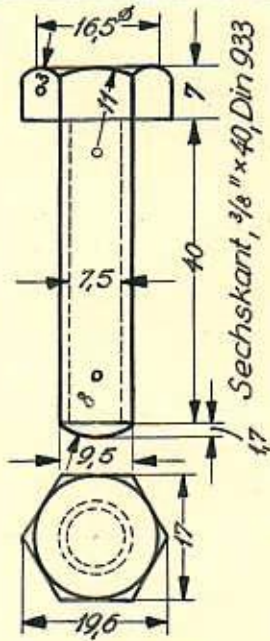

Sechskant, 3/8" x 40, Din 933

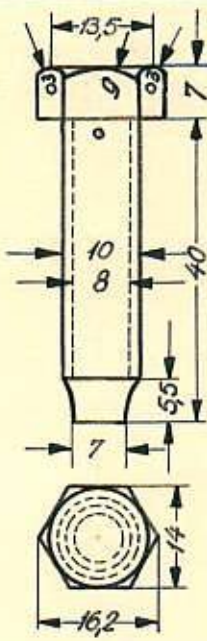

Sechskant, M 40 x 10, Din 561

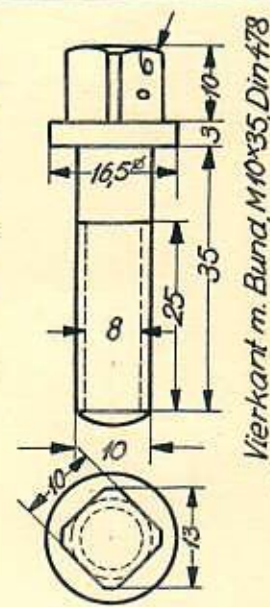

Vierkant m. Bund, M 10 x 35, Din 478

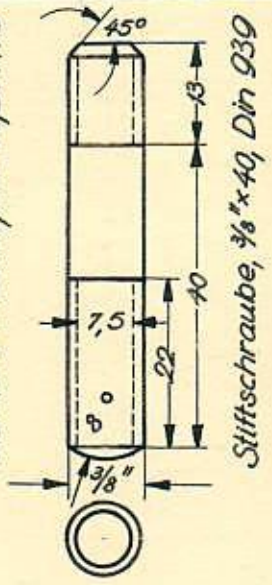

Stiftschraube, 3/8" x 40, Din 939

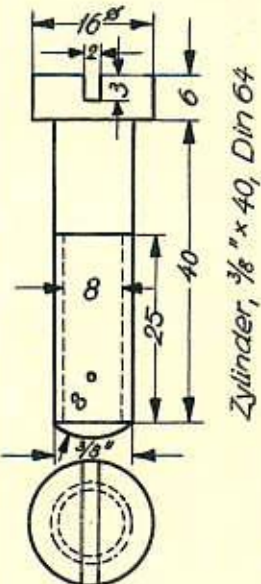

Zylinder, 3/8" x 40, Din 64

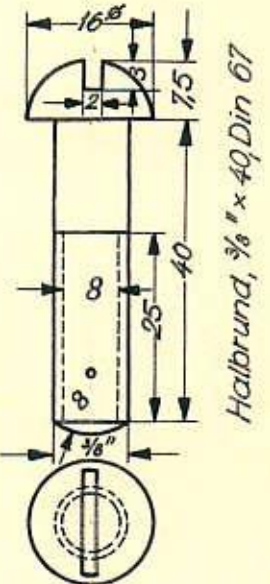

Halbrund, 3/8" x 40, Din 67

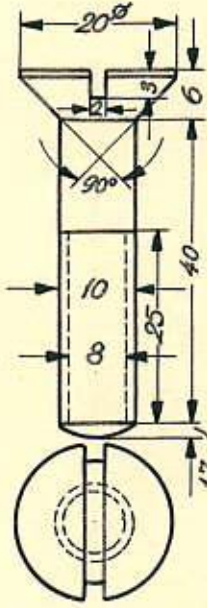

Senk, M 10 x 40, Din 87

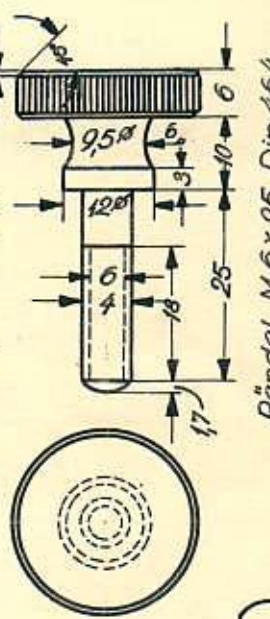

Rändel, M 6 x 25, Din 464

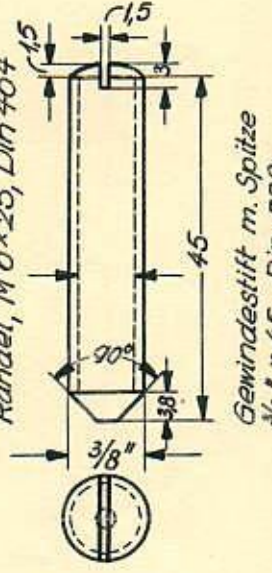

Gewindestift m. Spitze
3/8" x 45, Din 552

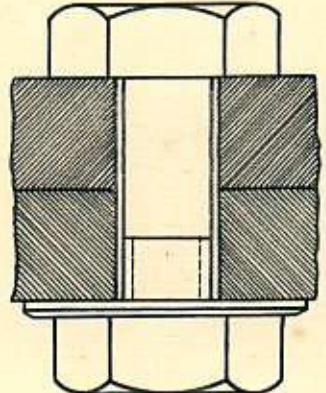
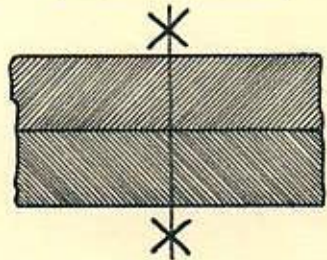
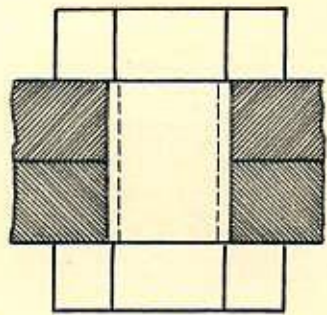
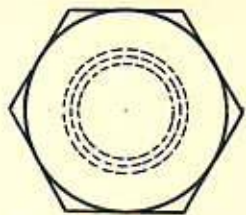
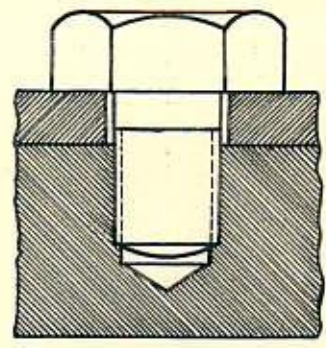

Berufsschule

24. 3. 54 - Z3

Schrauben

PFT 1A 1

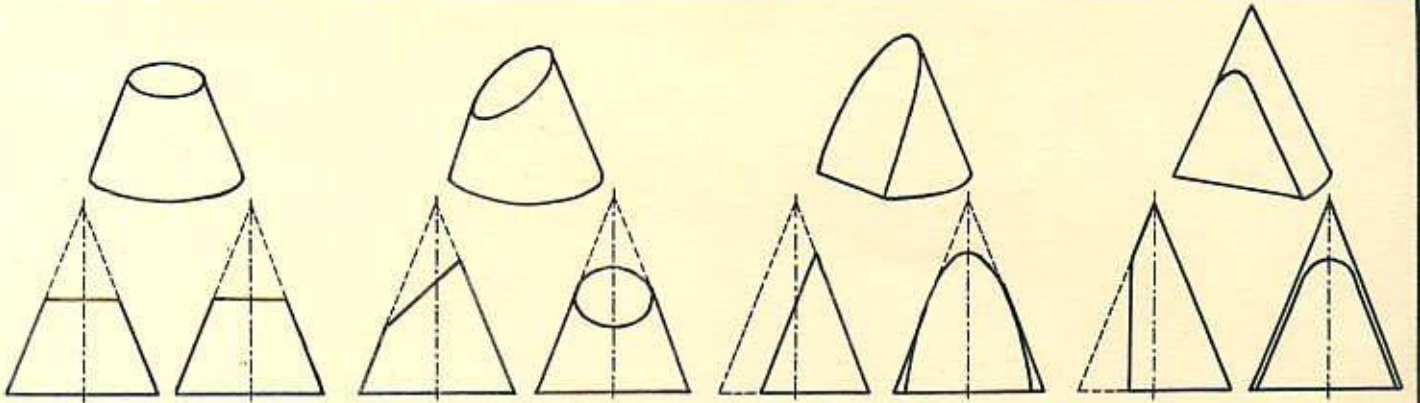

Schnitt parallel zur Grundfläche ergibt Kreis.

Schnitt schief zur Grundfläche ergibt Ellipse.

Schnitt parallel zur Mantelfläche ergibt Parabel.

Schnitt parallel zur Mittelachse ergibt Hyperbel.

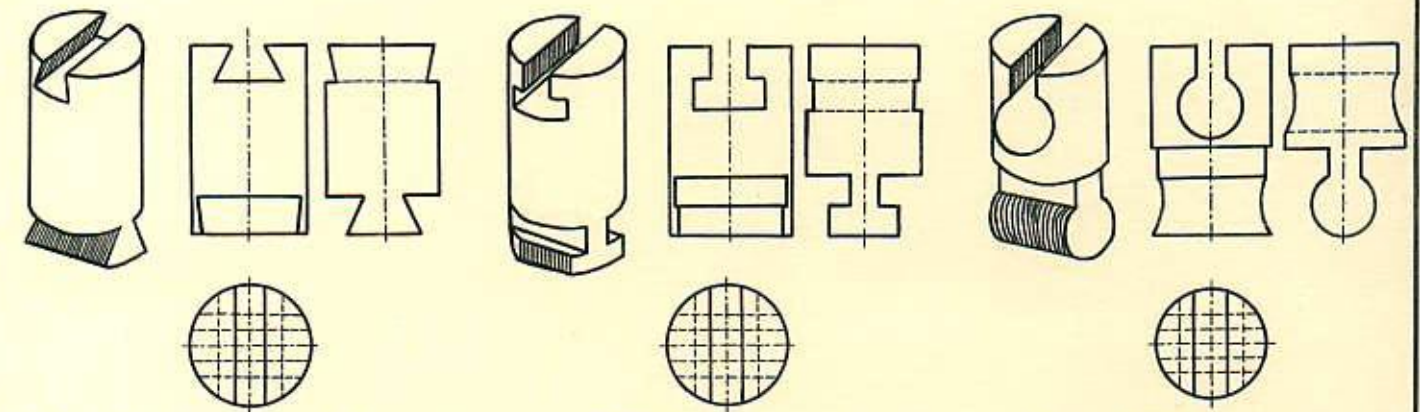
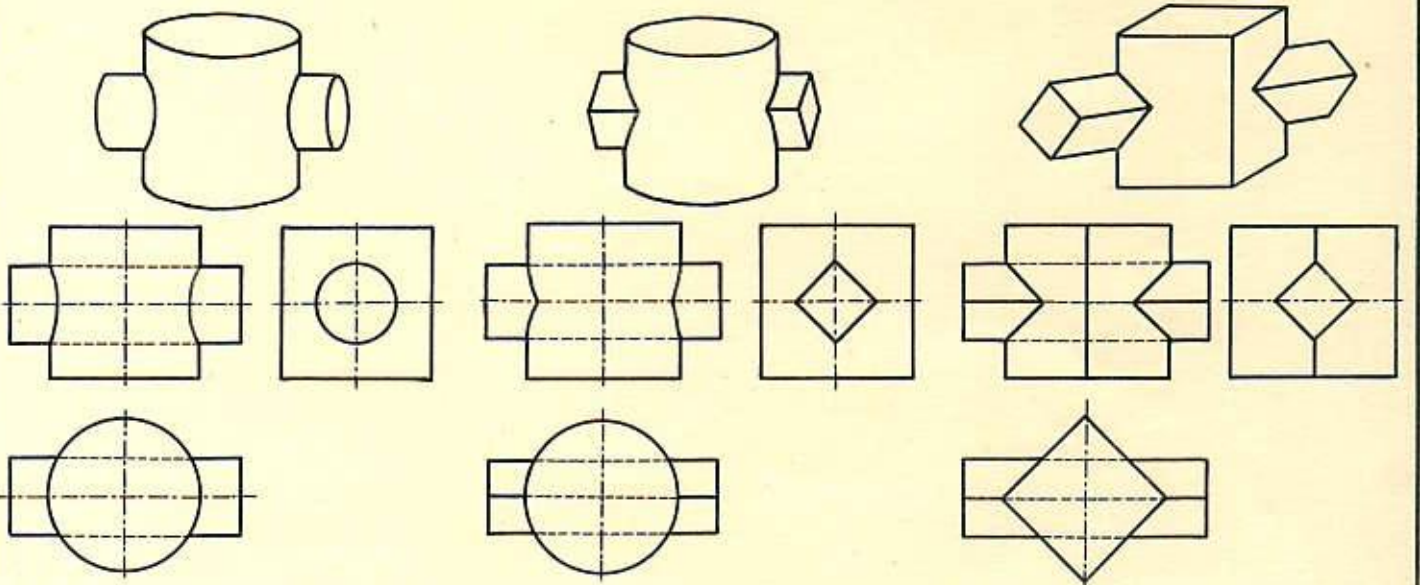

Schwalbenschwanzführung

T-Führung

Rundführung

Berufsschule

Kegelschnitte, Durchdringungen, Führungen

16.6.54 -Z4

PFT 1 A

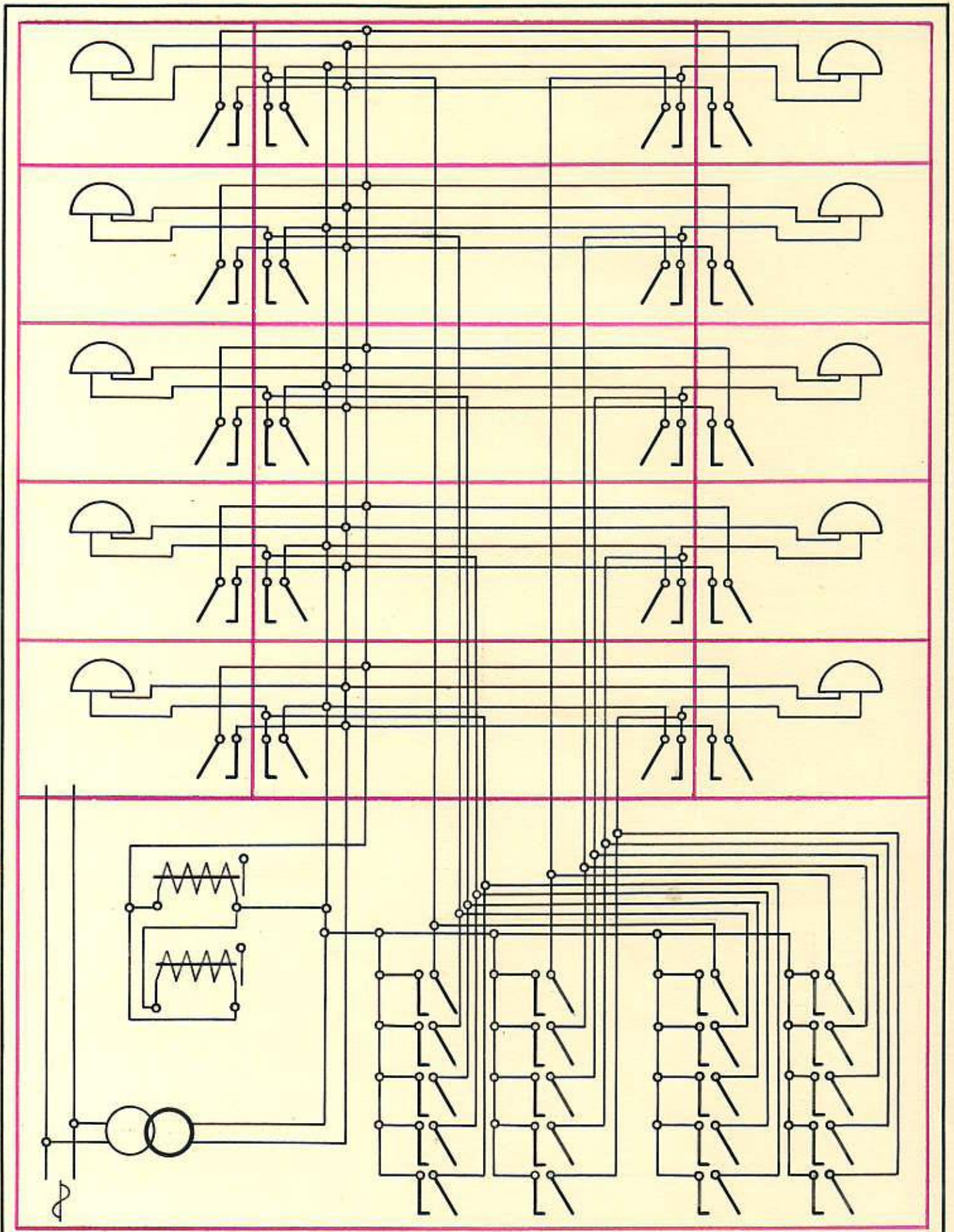

<p>Berufsschule 26.9.55-Z1</p>	<p>Hausweckerschaltung</p>	<p>PFT 3B 1-</p>
---	-----------------------------------	-------------------------

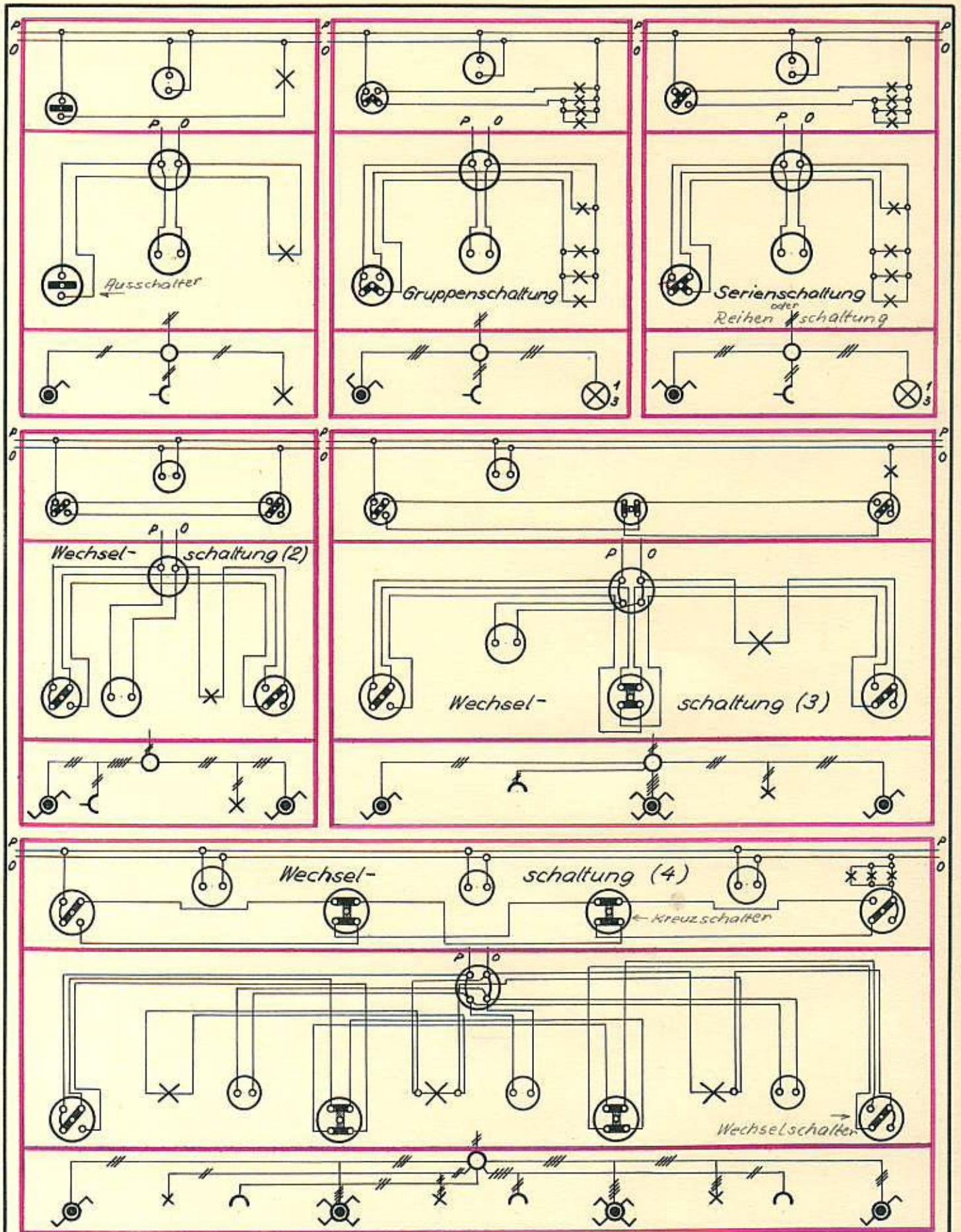

Berufsschule

7.11.55-Z2

Lampenschaltungen

PFT 3B

1

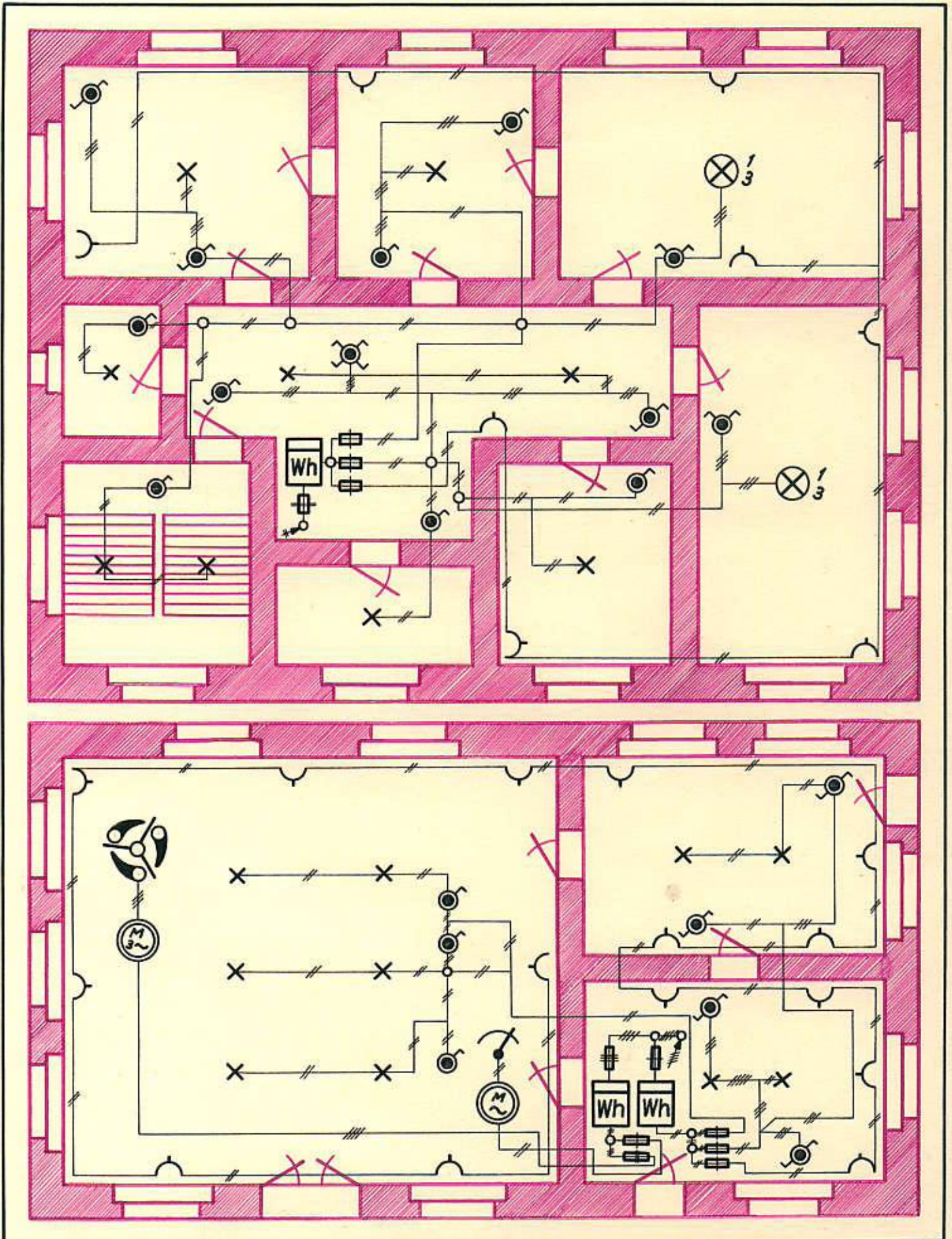

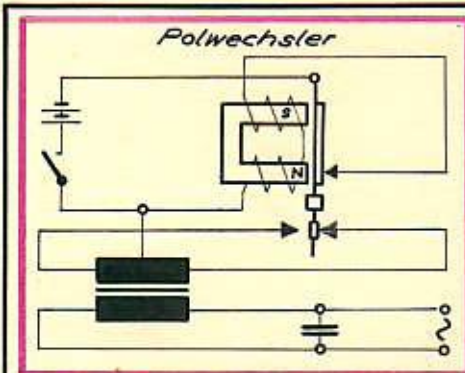

Polwechsler

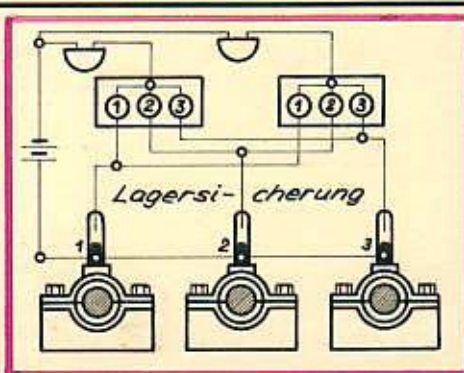

Lagersicherung

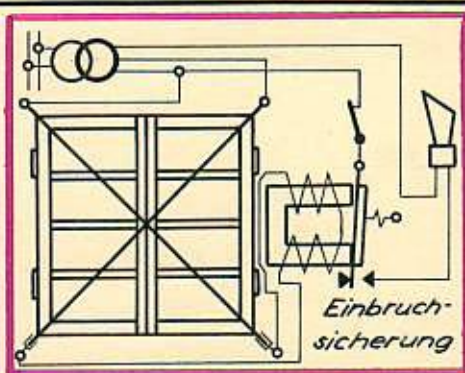

Einbruchsicherung

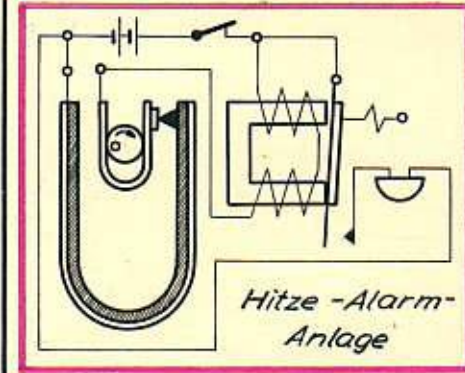

Hitze-Alarm-Anlage

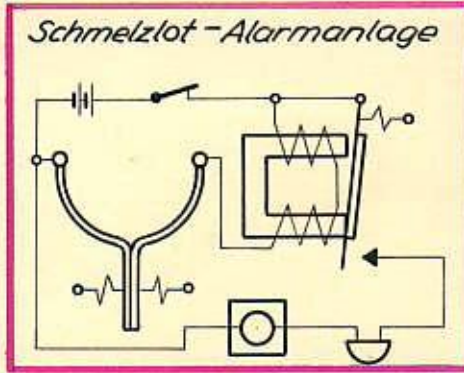

Schmelzlot-Alarmanlage

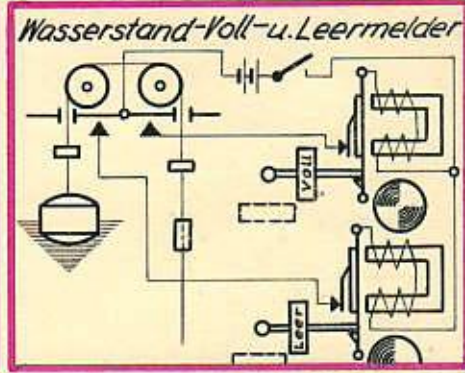

Wasserstand-Voll-u. Leermelder

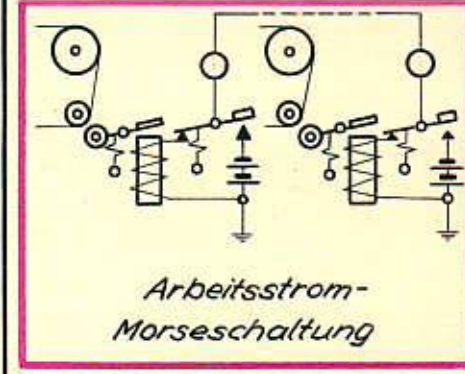

Arbeitsstrom-Morseschaltung

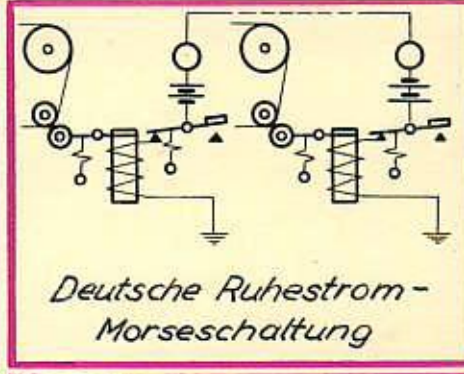

Deutsche Ruhestrom-Morseschaltung

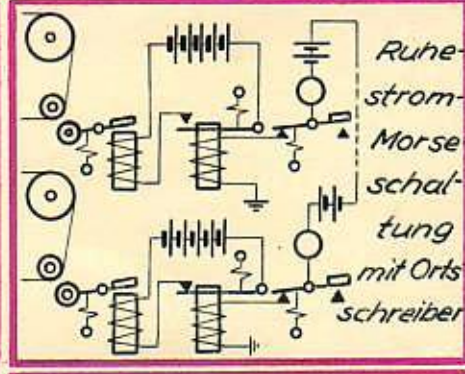

Ruhestrom-Morseschaltung mit Ortschreiber

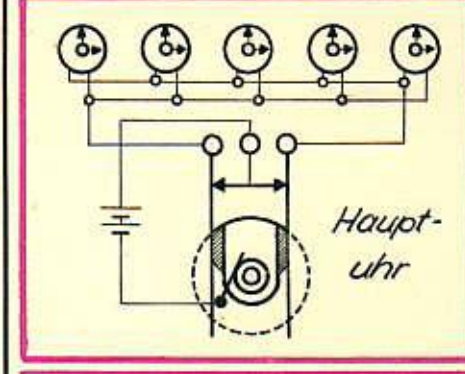

Hauptuhr

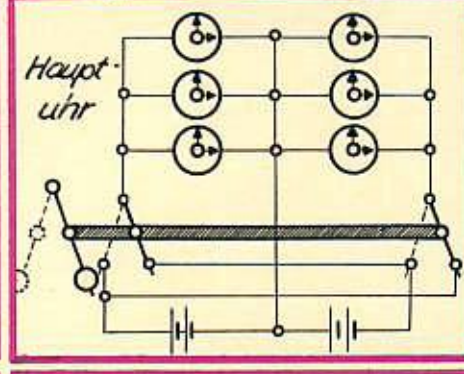

Hauptuhr

Nebenuhr

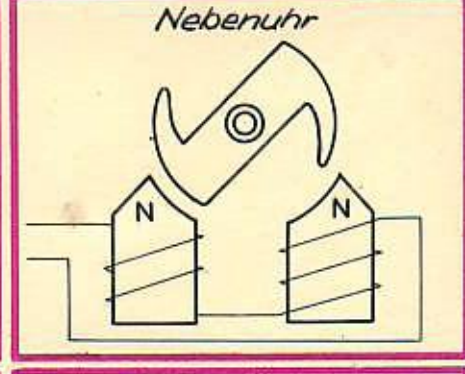

Strahlensicherungsanlage

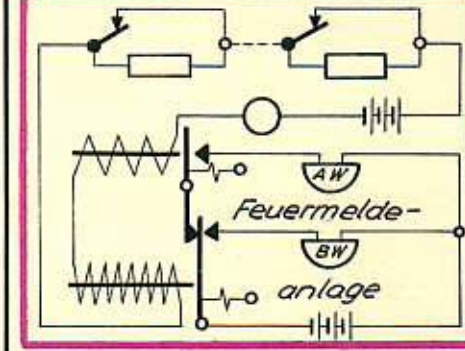

Feuermeldeanlage

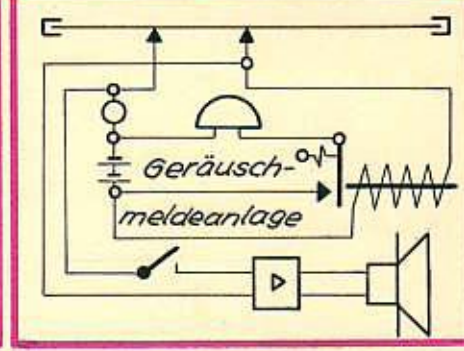

Geräuschmeldeanlage

Berufsschule
23.4.56 -Z4

Signalanlagen

PFT 3B 1

Foto
elem
allgen

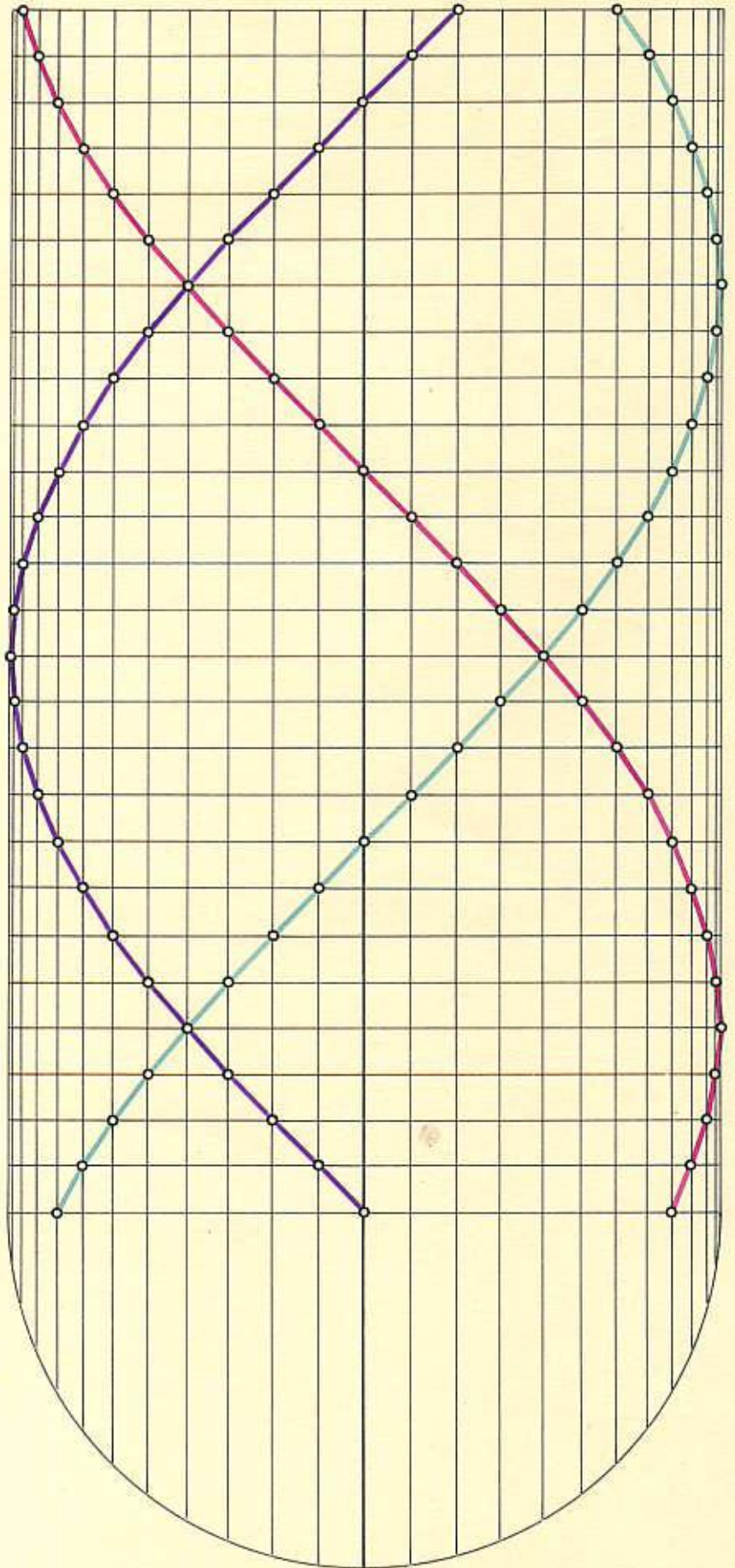
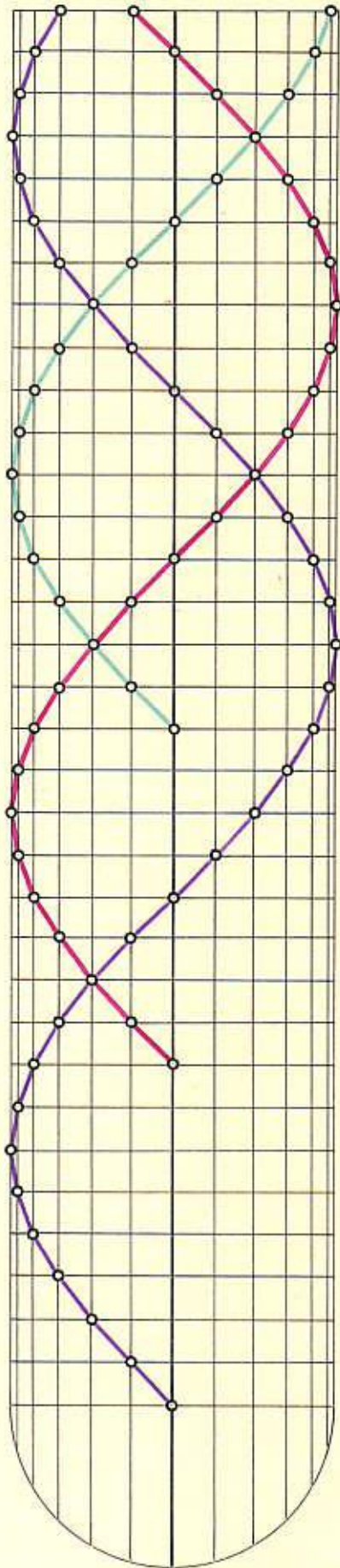

Berufsschule

9. 4. 56 - Z 6

Drehstromkurve

PFT 3B

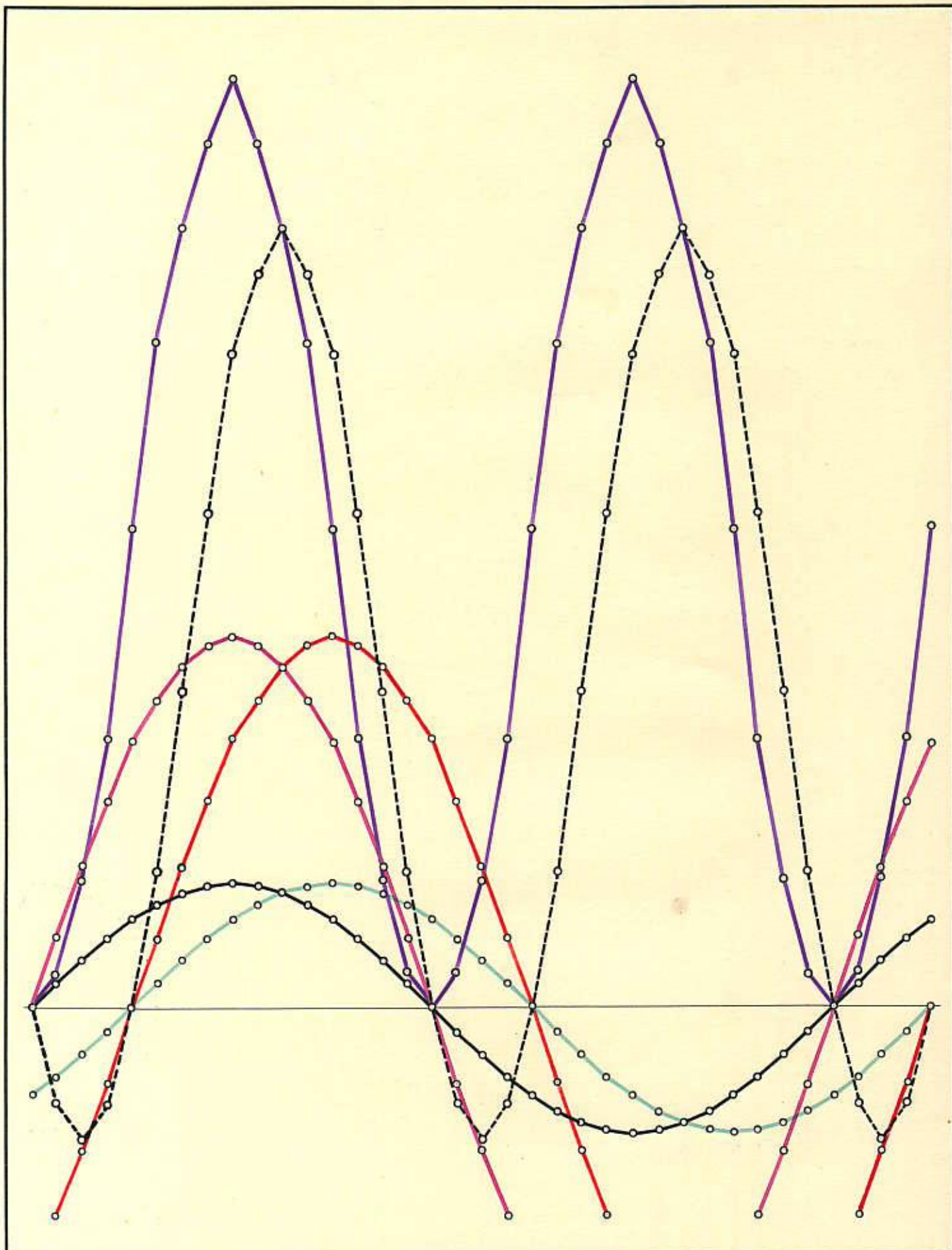

Berufsschule

18.6.56 -Z7

Leistungskurven

PFT 3B 1-